

**Performance criteria**

Tested according to	<b>EN 1906</b>
with 9 mm square spindle fire protection tested according to DIN 18273	<b>F</b>
Lever handle shape suitable for emergency exits and fire barrier doors	<b>EN 179</b>
Tested according to	<b>DIN 18 257</b>
Fixed swivel-mounted	■
Steel substructure Internal rose and external plate	■
Concealed, continuous screw attachment	■
Inside with lever handle / OGL <b>Click</b>	■
DIN L / R	■
With return spring	A
Suitable for resistance class <b>RC2</b> and <b>RC3</b>	■

Classification key EN 1906

4	7	-	B1/D1	1	4	2/3	A
---	---	---	-------	---	---	-----	---

■ Yes -No □ Optional

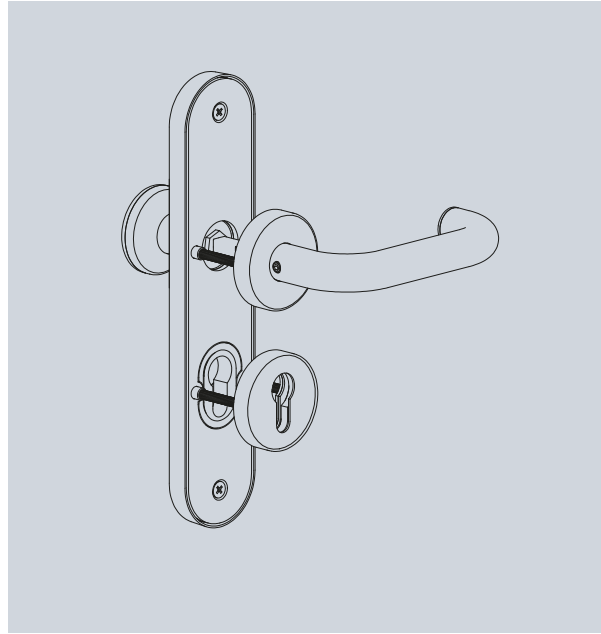

Material:

**ER** ER Stainless steel    **AI** AI Aluminium

Bearing technology:



**PRODUCT FAMILY D-100**

**Standard fitting**

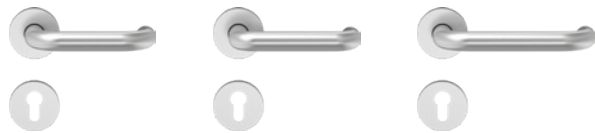

D-110

D-120

D-190

**Handle on oval rose**



D-115

D-116 .

**Window handle**



FO-110

**Handle on long/short plate**

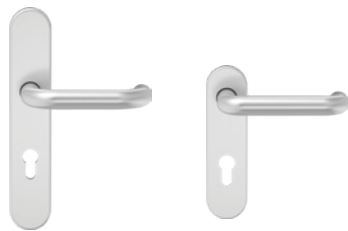

D-110 .

D-111

**Security handle**



D-110 .

D-110 .

D-111

D-116 .

# D-110 combined security handle ES 2



## D-110 combined security handle ES 2 with OGL Click







- Fixed swivel-mounted (via ECO OGL Click system) in maintenance-free friction bearing
- Fire protection approved
- Burglary security ES 2
- Suitable for resistance class RC 3
- Available as a knob/lever fitting with K-130/K-160/K-165 knob and G-150/G-160/G-180 handle plates.
- With return spring (type A)
- High-strength spindle connection (square spindle with longitudinal groove) with punching grub screw
- Use category class 4

### OG L – COMBINED SECURITY HANDLE



F = 4 7 - B1 1 4 3 A









				Security handle ZA/handle on rose PZ					
				K-130/D-110	K-160/D-110	K-165/D-110	G-150/D-110	G-160/D-110	G-180/D-110
	∅	Hole pattern	∇						
S	21 mm	72 mm	8 mm	5030056628	5030056684	On request	On request	5030056538	On request
F	21 mm	72 mm	9 mm	5030056588	5030056687	On request	On request	5030056536	On request

Finish: matt brushed; further colours and models available on request.



F = 4 7 - B1 1 4 3 A



				Security handle ZA/handle on rose PZ					
				K-130/D-110	K-160/D-110	K-165/D-110	G-150/D-110	G-160/D-110	G-180/D-110
	∅	Hole pattern	∇						
S	21 mm	72 mm	8 mm	5030056635	5030056711	On request	On request	5030056548	On request
F	21 mm	72 mm	9 mm	5030056632	5030056708	On request	On request	5030056546	On request

Finish: F1 anodised aluminium; further colours and models available on request.

The ZA model is designed for cylinder overhands of 10–15 mm.

S Standard fitting for door thicknesses: 38–45 mm. F Fire doors for door thicknesses: 44–54 mm. Combined security handles for other door thicknesses available on request.



# D-110 combined security handle ES 1



## D-110 combined security handle ES 1 with OGL Click







- Fixed swivel-mounted (via ECO OGL Click system) in maintenance-free friction bearing
- Fire protection approved
- Suitable for resistance class RC 2
- Available as a knob/lever fitting with K-130, K-160, K-165 knob and handle plates G-150, G-160, G-180 available.
- With return spring (type A)
- High-strength spindle connection (square spindle with longitudinal groove)
- with punching grub screw
- Use category class 4

### OG L – COMBINED SECURITY HANDLE



**F** = 4 7 - B1 1 4 2 A









				Security handle ZA/handle on rose PZ					
				K-130/D-110	K-160/D-110	K-165/D-110	G-150/D-110	G-160/D-110	G-180/D-110
	∅	Hole pattern	∇						
<b>S</b>	21 mm	72 mm	8 mm	5030048752	5030048753	5030048754	5030048755	5030048756	5030048757
<b>F</b>	21 mm	72 mm	9 mm	5030048758	5030048759	5030048760	5030048761	5030048762	5030048763

Finish: matt brushed; further colours and models available on request.



**F** = 4 7 - D1 1 4 2 A



				Security handle ZA/handle on rose PZ					
				K-130/D-110	K-160/D-110	K-165/D-110	G-150/D-110	G-160/D-110	G-180/D-110
	∅	Hole pattern	∇						
<b>S</b>	22 mm	72 mm	8 mm	5030048812	5030048814	5030048815	5030048817	5030048818	5030048819
<b>F</b>	22 mm	72 mm	9 mm	5030048820	5030048821	5030048822	5030048823	5030048824	5030048826

Finish: F1 anodised aluminium; further colours and models available on request.

The ZA model is designed for cylinder overhands of 10–15 mm.

**S** Standard fitting for door thicknesses: 38–45 mm. **F** Fire doors for door thicknesses: 44–54 mm. Combined security handles for other door thicknesses available on request.

# D-110 combined security handle ES 1



## Knobs

K-130 / D-110

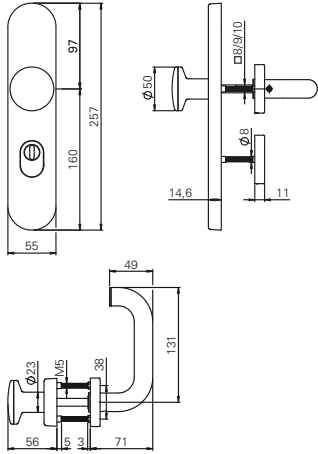

K-160 / D-110

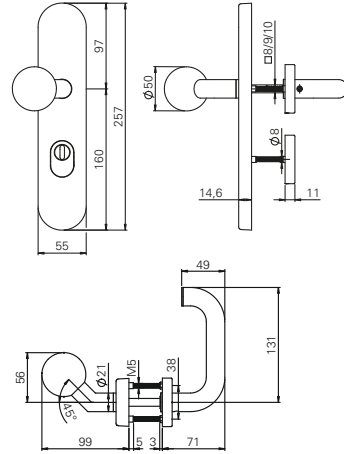

K-165 / D-110

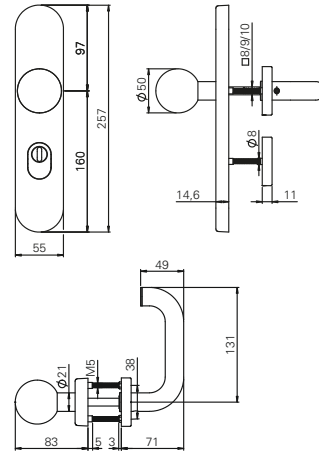

## Handle plates

G-150 / D-110

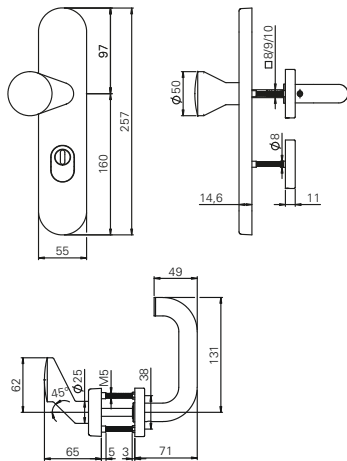

G-160 / D-110

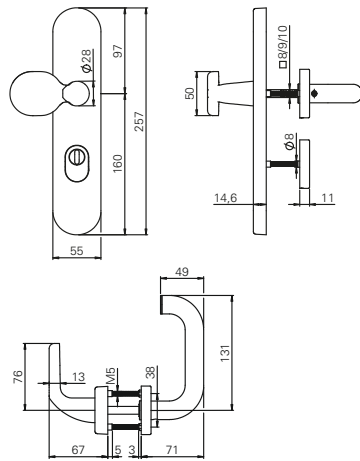

G-180 / D-110

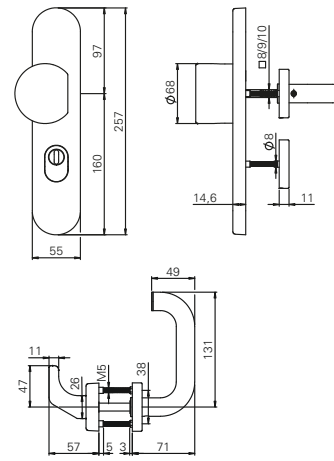

## Knobs

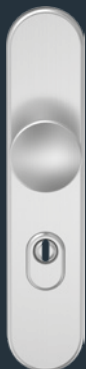

ES 1 long plate  
ZA / K-130

ES 1 long plate  
ZA / K-160

ES 1 long plate  
ZA / K-165

ES 1 long plate  
ZA / G-150

ES 1 long plate  
ZA / G-160

ES 1 long plate  
ZA / G-180

# Product information and use of ECO fitting technology

## § 1 Product information and intended usage

1. The fitting systems made by ECO are assistive systems that can be used to help with opening and closing motions and/or locking processes for doors, glass doors and window elements.
2. The fixing elements supplied with these products must be used and installed according to the mounting instructions/specifications.

## § 2 Improper use of the products

Improper use of fitting systems for doors and windows (i.e. not using the product as intended) includes the following situations in particular:

- Installation or mounting of foreign objects and/or objects not intended for this purpose into the fitting system;
- Using auxiliary tools to operate the system;
- The fittings are used as a replacement for a missing wall buffer;
- Fittings are misused as a suspension device for heavy loads;
- Fittings are used long-term in combination with panic locks instead of only in emergencies, against the recommendation of the lock and fitting industry;
- Surface of the fitting systems damaged by the use of sharp or hard objects;
- The use of fasteners made by third-party manufacturers.

Sooner or later, these errors will cause damage, and the products will no longer have the characteristics defined by the manufacturer.

## § 3 Product performance

1. Product performance is only partially governed by standards. Many aspects of product performance have been developed based on years of experience and should be considered common knowledge in the construction hardware industry. Correspondingly, the contents of these standards and these empirical values should also be applied to fittings that are not expressly regulated.
2. Specifically, the following standards apply:
  - EN 1906: General benchmarks for door fittings and accessories;
  - DIN 18273: Special rules for fire and smoke control doors;
  - DIN 18257: Minimum security requirements for security fittings.
3. The fitting system must be replaced if, despite maintenance and servicing, it can no longer be ensured that it will function properly, and/or it may pose a risk of injury.
4. Furthermore, the products are continuously being improved, and manufacturing is subject to quality assurance. The right to make technical changes is reserved.

## § 4 Product maintenance

1. The user must ensure that the fitting systems and fixing elements are installed in a proper functional manner.
2. Depending on the material and where they are used, the products will face a certain degree of natural wear and tear. Consequently, all moving parts must undergo maintenance at least once per year; i.e. the proper fit, stability of the screw connections etc. must be checked on a regular basis. Only water, gentle cleaning agents and other cleaning agents that do not contain corrosive ingredients should be used for cleaning the fitting systems.
3. Manufacturing primarily uses the materials nylon, aluminium, stainless steel and brass. Please note that each of these different materials has different maintenance and servicing requirements.

## § 5 Duty to inform and instruct

1. The following documents are available to provide information and instruction:
  - Catalogues and brochures;
  - Tender documents;
  - Procurement information;
  - Bid documents;
  - Installation and operating instructions;
  - DIN standards.
2. In order to ensure that the fitting systems function properly:
  - Architects, planners and any other people involved in the process are required to request all the necessary product information from us and to comply with said information,
  - Specialised retailers are required to observe the product information and notes in the price lists and catalogues and, in particular, to request all required instructions from us and to pass them on to the processors,
  - The processors are required to obtain all product information and to comply with it, and, in particular, to request the operating and maintenance instructions from us and pass them on to the customers and users.

Overall, all parties involved must ensure that the fitting systems are properly assembled and installed and that each end user receives proper instructions and explanations.

# General information

## ECO Schulte recommends

For lever handle sets without a return spring, we recommend using locks that comply with DIN 18251 - class 3 or higher

In order to minimise the clearance between the lever handle set and the lock, we recommend locks that comply with DIN 18251 with a clamping nut.

When ECO handles are properly installed and used, the paint should withstand daily use. Excessive contact with hard or sharp objects (such as key rings, rings etc.) can scratch the surface. This does not impair functionality, however.

Our Compendium presents a compilation of all the products in our range. These are each subject to different supply classes. Special models are often configured to specific customer wishes and sometimes require longer lead-times and minimum order quantities. Your contact will be happy to advise you.

**ECO Schulte GmbH & Co. KG**

Iserlohner Landstraße 89

D-58706 Menden

Telephone +49 2373 9276 - 0

Telefax +49 2373 9276 - 40

[info@eco-schulte.de](mailto:info@eco-schulte.de)

[www.eco-schulte.de](http://www.eco-schulte.de)

Our compendium represents a compilation of all products from our range of services. These are subject to different delivery classes. Special variants included are often manufactured to customer specifications and sometimes require longer delivery times and minimum purchase quantities. Further advise can be given by your contact person.

## ■ SYSTEM TECHNOLOGY FOR THE DOOR

